



Basic Data

Product Number	Wattage	Color Temp.	Voltage	Lumens	Working Hours	CRI
EX-20W B2YZDA	20	4000K-5700K	AC100-277V	2800	5 years	70
EX-40W B2YZDA	40	4000K-5700K	AC100-277V	5600	5 years	70
EX-60W B2YZDA	60	4000K-5700K	AC100-277V or AC200-480V	8400	5 years	70
EX-80W BYZDA	80	4000K-5700K	AC100-277V or AC200-480V	11200	5 years	70
EX-100W BYZDA	100	4000K-5700K	AC100-277V or AC200-480V	14000	5 years	70
EX-150W B3YZDA	150	4000K-5700K	AC100-277V or AC200-480V	21000	5 years	70
EX-180W B3YZDA	180	4000K-5700K	AC100-277V or AC200-480V	25200	5 years	70
EX-200W B3YZDA	200	4000K-5700K	AC100-277V or AC200-480V	28000	5 years	70

B,B2,B3 product code "Y"=D or N:Dimmable or non-dimmable "Z"= CCT, from 4000~5700K "D"=Beam angle, D40 for 40°,D60 for 60°,D90 for 90°, D120 for 120° A for glass info. blank for flat glass, C for spherical glass.

Dimensions

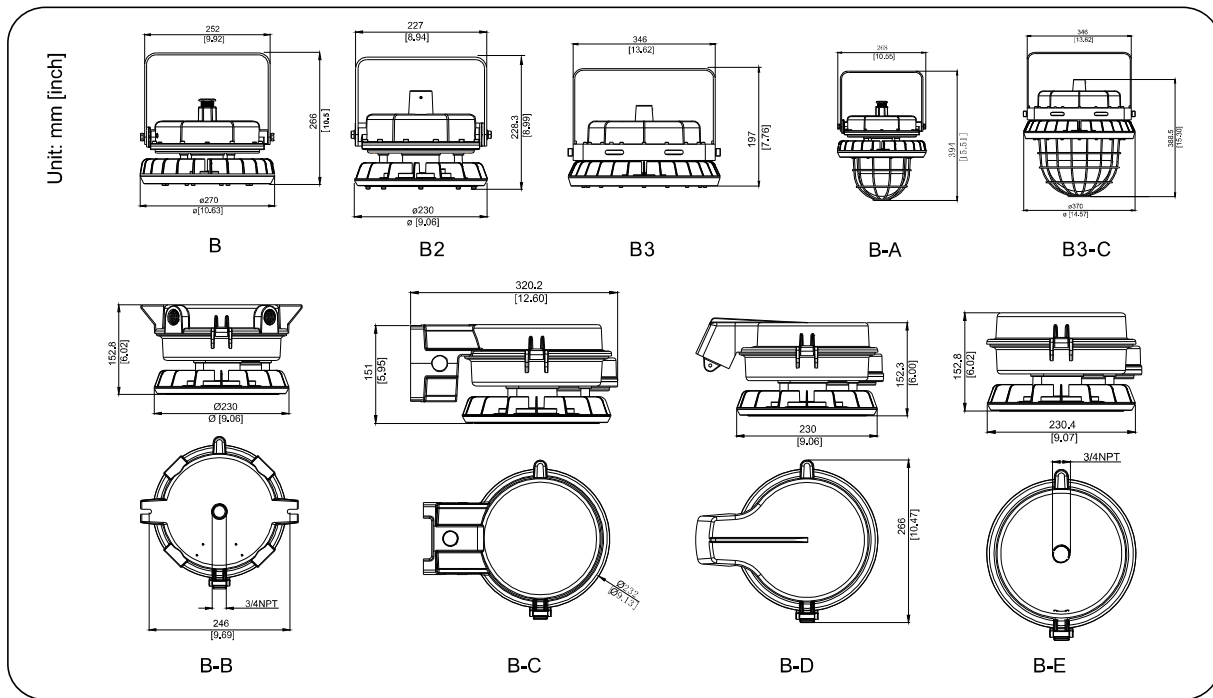

Lighting Distribution

200W/120D

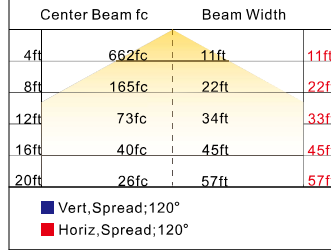

200W/90D

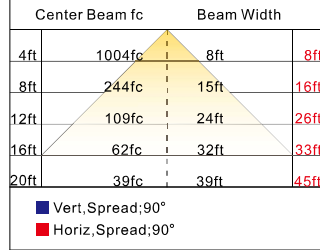

200W/60D

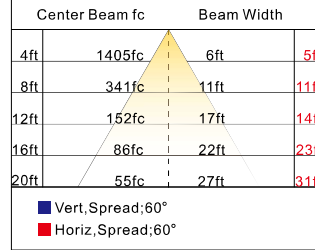

200W/40D

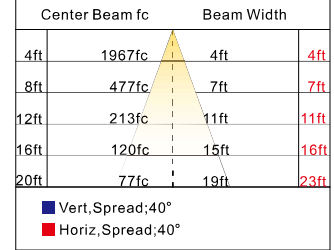

Installation

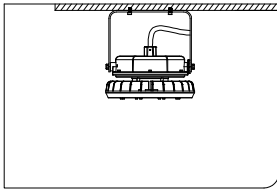

Ceiling Bracket Mounting

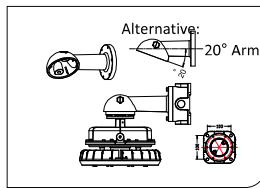

Alternative Arm Mounting

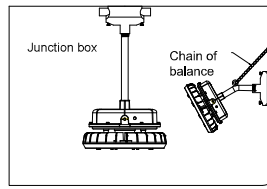

Pendant Mounting

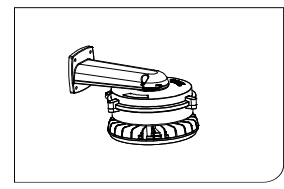

Arm Mounting

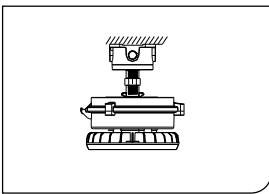

Junction Box Mounting

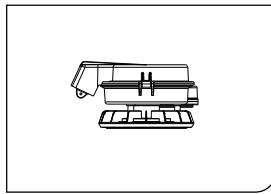

Stanchion Mounting

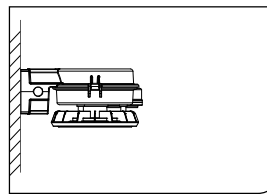

Direct Ceiling Mounting

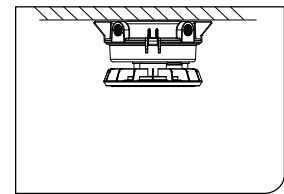

Direct Wall Mounting

Approvals

Marking Atex	II2 G Ex db IIB T6 Gb II2 D Ex db IIIC T80 Db IP66
Marking IECEX	Ex db IIB T6 Gb Ex db IIIC T80 Db IP66
Marking UL844 <small>(North American)</small>	Class I, Division 2, Groups A, B, C, D Class II, Division 1, Groups E, F, G Class II, Division 2, Groups E, F, G Class III
Marine Marking	UL 1598A ABS and DNV Type Approved
Other Rating	IP 66 IK 10